

# PD Signal Time-Frequency Map and PRPD Pattern Analysis of Nano SiO<sub>2</sub> Modified Palm Oil for Transformer Insulation Applications

R. K.Arvind Shriram\*, S.Chandrasekar<sup>†</sup> and B.Karthik\*\*

**Abstract** – In recent times, development of nanofluid insulation for power transformers is a hot research topic. Many researchers reported the enhancement in dielectric characteristics of nano modified mineral oils. Considering the drawbacks of petroleum based mineral oil, it is necessary to understand the dielectric characteristics of nanofluids developed with natural ester based oils. Palm oil has better insulation characteristics comparable to mineral oil. However very few research reports is available in the area of nanofluids based on palm oil. Partial discharge (PD) is one of the major sources of insulation performance degradation of transformer oil. It is essential to understand the partial discharge(PD) characteristics by collecting huge data base of PD performance of nano modified palm oil which will increase its confidence level for power transformer application. Knowing these facts, in the present work, certain laboratory experiments have been performed on PD characteristics of nano SiO<sub>2</sub> modified palm oil at different electrode configurations. Influence of concentration of nano filler material on the PD characteristics is also studied. Partial discharge inception voltage, Phase resolved partial discharge (PRPD) pattern, PD signal time-frequency domain characteristics, PD signal equivalent timelength-bandwidth mapping, Weibull distribution statistical parameters of PRPD pattern, skewness, repetition rate and phase angle variations are evaluated at different test conditions. From the results of the experiments conducted, we came to understand that PD performance of palm oil is considerably enhanced with the addition of nano-SiO<sub>2</sub> filler at 0.01%wt and 0.05%wt concentration. Significant reduction in PD inception voltage, repetition rate, Weibull shape parameter and PD magnitude are noticed with addition of SiO<sub>2</sub> nanofillers in palm oil. These results will be useful for recommending nano modified palm oil for power transformer applications.

**Keywords:** Power transformer, Nanofluid, Partial discharge, Liquid insulation, Frequency spectrum

## 1. Introduction

Power transformer is the most expensive component in power system and its breakdown occurs mainly due to performance degradation of liquid insulation. At present several research works are being conducted to avoid the usage of conventional mineral oil insulation considering its drawbacks and to find an alternate natural ester based insulation for transformers [1-3]. Natural ester oils are biodegradable and are easily available. Reports are available on the dielectric characteristics of palm oil, corn oil, sunflower oil, olive oil, coconut oil and castor oil [4-7].

Recent advancements in nanotechnology offer possibilities for the development of nanofluid insulation for transformers. The selection of suitable base oil along with nano filler material provides more appropriate nano fluid for power transformer applications. Many researchers

reported the enhancement in dielectric characteristics of nano modified mineral oils [8-14].

However very few research reports is available in the area of vegetable oil based nanofluids for transformer applications [15-16]. Palm oil has better insulation characteristics comparable with mineral oil [4-6]. Hence development of nano modified palm oil with enhanced insulation performance will be useful for electrical utilities. Partial discharge (PD) is one of the major sources of insulation performance degradation of transformer oil [1,6,17-18]. PD mainly starts due to the enhancement of local electric field in the oil/paper insulation caused by the presence of cavity, void, bubbles, metal particles, etc. and it gradually speeds up the degradation and aging of the oil insulation system. In general, PD can be classified as corona and surface discharges. Corona discharge occurs due to the presence of sharp edges and surface discharge occurs at the oil/pressboard interface. Understanding the PD characteristics and collection of huge data base of PD performance of nano modified palm oil is very essential in the present scenario. This will increase its confidence level for power transformer application. However, detailed reports on PD characteristics of palm oil based nanofluid insulation are scanty. Having known this, in this work, PD

<sup>†</sup> Corresponding Author: Dept. of Electrical and Electronics Engineering, Sona College of Technology, Salem, India. (chandruktv@gmail.com)

\* Research Scholar, Anna University Chennai, India. (rsriram1987@gmail.com)

\*\* Dept. of Electrical and Electronics Engineering, Sona College of Technology, Salem, India. (karthik\_pse@yahoo.co.in)

Received: May 17, 2017; Accepted: December 4, 2017

characteristics of palm oil added with nano SiO<sub>2</sub> fillers at different %wt concentrations was evaluated. Surface PD and corona PD were simulated at different electrode configurations. PD inception voltage, PRPD pattern, PD signal time-frequency domain characteristics, PD signal equivalent timelength-bandwidth mapping, Weibull distribution statistical parameters of PRPD pattern, skewness, repetition rate and phase angle variations were evaluated at different test conditions.

## 2. Experimental Setup

### 2.1. Preparation of Nano-SiO<sub>2</sub> modified palm oil

Commercially available palm oil is used as a base fluid and its properties are listed in table 1. At the start, palm oil sample was placed in a sealed steel container and thermal treatment was done at 60°C for 24 hours inside a temperature controlled oven in order to remove moisture content and then the sample was allowed to cool to room temperature for 24 hours.

To prepare the nanofluid samples at 0.01, 0.05 and 0.1% wt concentrations, Silica nano particles of size less than 80nm with high purity (99%) which was supplied by Hefei Jiankun Chemical Industry have been used. Fig. 1 shows the photograph of nano modified palm oils

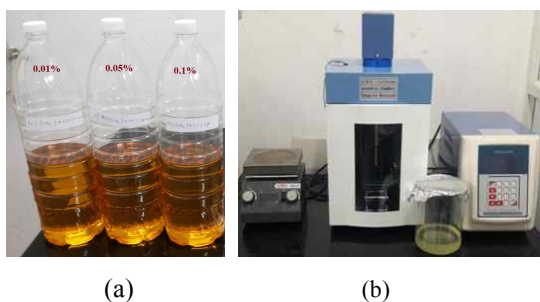
**Table 1.** Properties of palm oil as per manufacturer’s data

	FP1 °C	FP2 °C	V@40°C mm <sup>2</sup> /s	M %	SFA %	MUSFA %	PU SFA %
P	250	260	37	0.12	50	39.5	10.5

P-palm, FP1-Flash point, FP2-Fire point, V-Viscosity, M-Moisture, SFA-Saturated fatty acid, MUSFA-Monounsaturated fatty acid, PUSFA-polyunsaturated fatty acid

**Table 2.** Sample identity of nano-modified palm oil

Sample Identity	Detail
A	Pure palm oil
B	PO + 0.01% SiO <sub>2</sub>
C	PO + 0.05% SiO <sub>2</sub>
D	PO + 0.1% SiO <sub>2</sub>

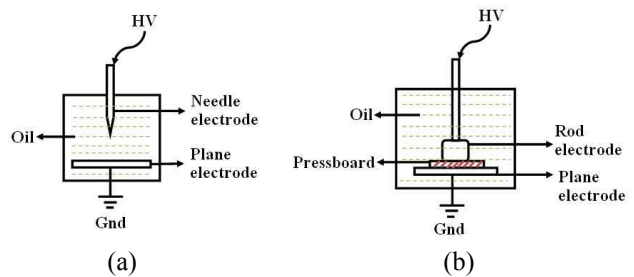


**Fig. 1.** (a) Nano Silica modified palm oil at different %wt concentration of nanofiller (b) Lab setup of magnetic stirrer and ultrasonication process

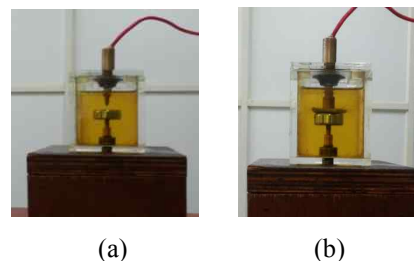
developed in the laboratory and the magnetic stirrer and ultrasonicator were used for enhancing the stability of the nanofluid. Initially, magnetic stirrer operation is carried out for 45 minutes with required amount of nanofiller material added with the base palm oil in order to enhance the dispersal of aggregations in the base palm oil. Then ultrasonication process is carried out for 20 minutes to get a well dispersed nanofluid. These two process helps to avoid the agglomeration and sedimentation of nanoparticles in the palm oil. Table 1 shows the sample identity of nano modified palm oils used in this work.

### 2.2. Generation of PD Sources using Needle-Plane and Rod-Plane Electrode Configuration

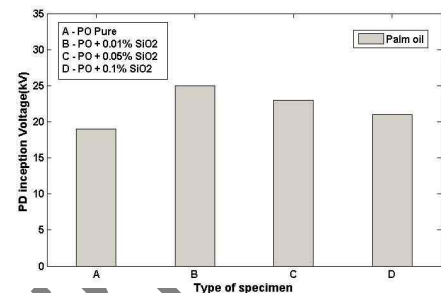
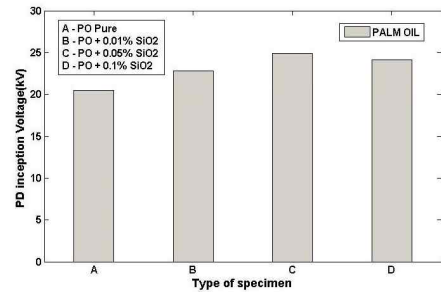
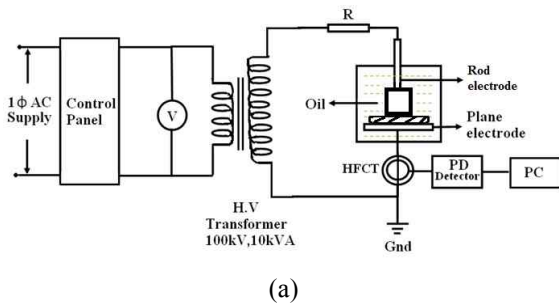
Corona PD was simulated in the laboratory using needle-plane electrode geometry. Fig. 2(a) and 3(a) shows the schematic and photograph of needle-plane electrode geometry used the in the lab. Corona PD was produced with a needle of 20 μm tip radius. Gap distance between the electrodes was maintained at 3 mm. Fig. 2(b) and 3(b) shows the schematic and photograph of rod-plane electrode geometry used the in the lab for generating surface PD. Size of the rod electrode is 10 mm diameter and 10 mm height. Size of the plane electrode is of 25 mm diameter and 10 mm height. While maintaining the gap distance between the electrodes as 5 mm, a pressboard material of 5 mm thickness was placed in between the rod-plane electrode as shown in Fig. 3(b) in order to generate surface discharges of sufficient magnitude [1,6].



**Fig. 2.** (a) Needle-plane electrode configuration used for corona discharge generation (b) Rod-plane electrode configuration used for surface discharge generation.



**Fig. 3.** Photograph of test cell filled with nano-modified palm oil (a) corona discharge generation (b) surface discharge generation



(a)

(b)

(a)

(b)

**Fig. 4.** (a) Schematic diagram of the laboratory PD measuring setup (b) Corresponding photograph of lab facility

### 2.3. Partial discharge measurement lab setup

PD measurement is carried out as per IEC 60270 procedures. Fig. 4(a) and 4(b) shows the schematic and photograph of lab experimental setup used for PD measurement respectively. High voltage AC source of 100 kV rating is used for providing supply during PD test. Test cell is filled with nano-palm oil prepared at different %wt concentrations. High frequency current transformer (HFCT) was clamped around the ground lead for measuring PD signals. It has a 50 MHz bandwidth which is sufficient to cover the entire range of corona and surface PD.

Output of the HFCT sensor is connected to the PD equipment, PDCheck (TechIMP), which has 100 MSa/s sampling rate and 50 MHz bandwidth. Sensitivity of PDCheck is 2 mV/div to 5 V/div, which provides entire digitized PD pulse waveforms during acquisition [20-21].

## 3. Results and Discussion

### 3.1 Analysis of Partial Discharge Inception Voltage (PDIV) of Nano Modified Palm Oil

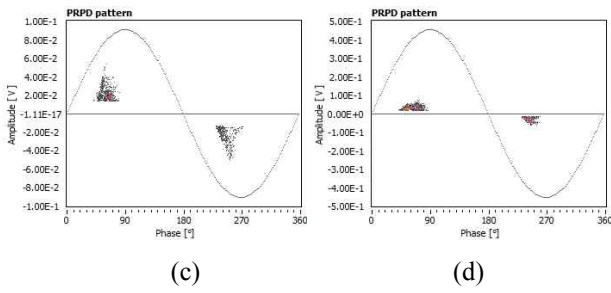
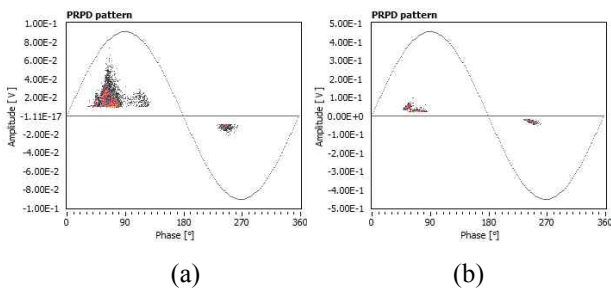
PDIV is calculated as the minimum voltage at which observable PD signals appear on the PD measuring system. Supply voltage is slowly increased from 1 kV until at least one PD signal is detected over an interval of 10 minutes at stable condition after voltage application. A set of 5 PD measurements were carried out at each voltage magnitude

**Fig. 5.** PDIV of nano SiO<sub>2</sub> modified palm oil obtained at (a) needle-plane electrode configuration (b) rod-plane electrode configuration

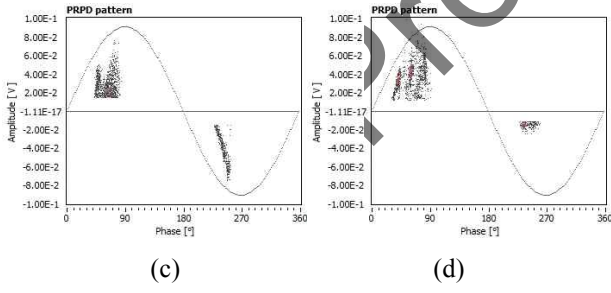
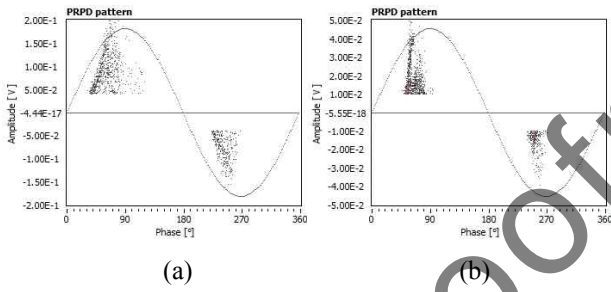
in order to achieve the 95 % of confidence level. Fig. 5 shows the PDIV value of nano modified palm oil at different electrode configurations. It is generally observed that nano SiO<sub>2</sub> modified palm oils show higher PDIV compared with type A pure oil specimen. Type C and B specimen show 25% and 15% increase in PDIV than type A specimen at needle-plane and rod-plane configuration respectively. However, it is also noticed that 0.1%wt concentration (type D) shows slight reduction in PDIV compared with B and C specimen, which may be due to the higher concentration of nanofillers resulting in agglomeration of particles and reducing the advantage of nanosize fillers. In general, rod-plane electrode arrangement show slightly reduced PDIV due to the presence of pressboard material closer to the electrodes, when compared with needle electrode. This gives more probability for the initiation of PD sites at the surface micropores of pressboard material.

### 3.2 PRPD Pattern Analysis of Nano Modified Palm Oil at Different Electrode Arrangement

Fig. 6 and 7 shows the typical PRPD patterns obtained with needle-plane and rod-plane electrode configurations respectively. Sine waveform is used as a phase reference signal in the PRPD pattern. Type C specimen shows less PD activities at needle-plane and type B specimen shows less PD activities at rod-plane configuration. It is noticed that pure oil type A specimen shows higher PD activities

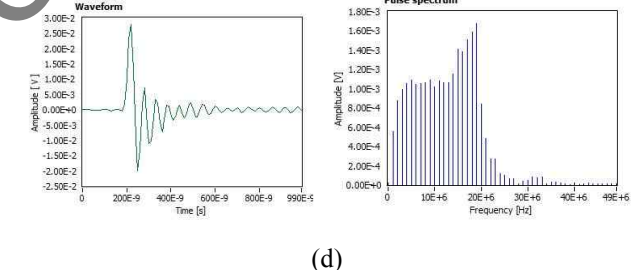
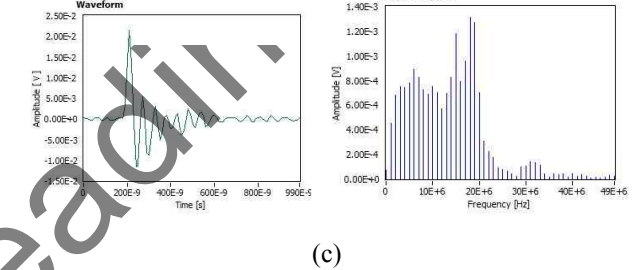
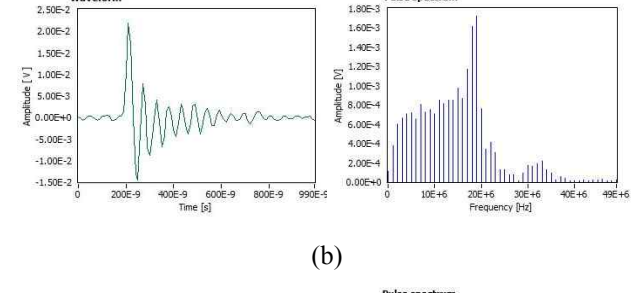
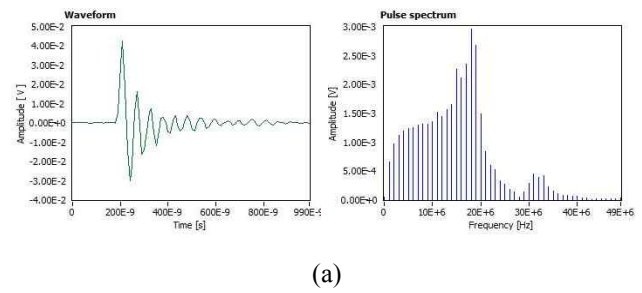


**Fig. 6.** Typical PRPD pattern of nano silica modified palm oil obtained at needle-plane electrode configuration (a) Type A (b) Type B (c) Type C (d) Type D. Test Voltage-26 kV



**Fig. 7.** Typical PRPD pattern of nano SiO<sub>2</sub> modified palm oil obtained at rod-plane electrode configuration: (a) Type A (b) Type B (c) Type C (d) Type D. Test Voltage-28 kV

than nano modified specimens in both electrode configurations. In general, PD activity is more severe in the case of positive half cycle similar to the results reported in earlier papers [17-19]. Earlier works reports that pure natural ester based palm oil shows higher PD activities than mineral oil. It is noticed that addition of SiO<sub>2</sub> nanofillers significantly reduces the PD activities.



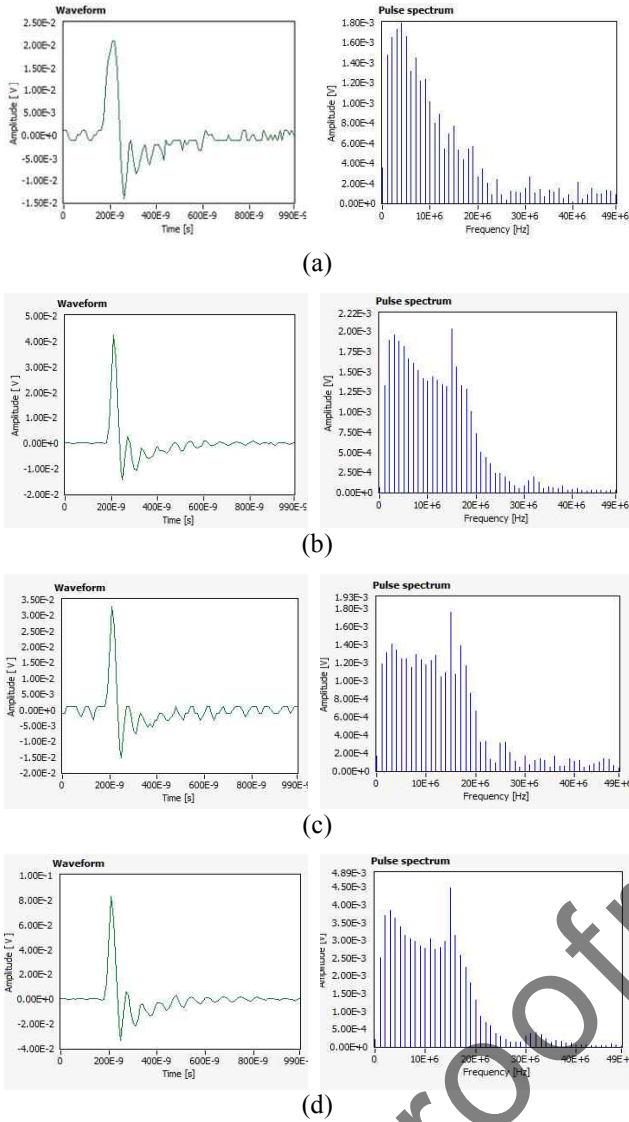
**Fig. 8.** Typical PD pulse and corresponding frequency spectrum of nano SiO<sub>2</sub> modified palm oil obtained at needle-plane electrode configuration: (a) Type A (b) Type B (c) Type C (d) Type D

**3.3 PD signal time domain and frequency spectrum analysis of nano modified palm oil**

Time and frequency domain analysis of PD signal characteristics of nano modified palm oil will be useful for extracting important features for the development of efficient condition monitoring system for transformers. Fig. 8 and 9 shows the PD signal (left) and corresponding frequency spectrum (right) of nano modified palm oil at needle-plane and rod-plane geometry respectively.

From the frequency spectrum characteristics of needle-plane geometry, it is noticed that peak value occurs at around 18 MHz irrespective of the type of specimen. Whereas under rod-plane geometry, it is observed that peak



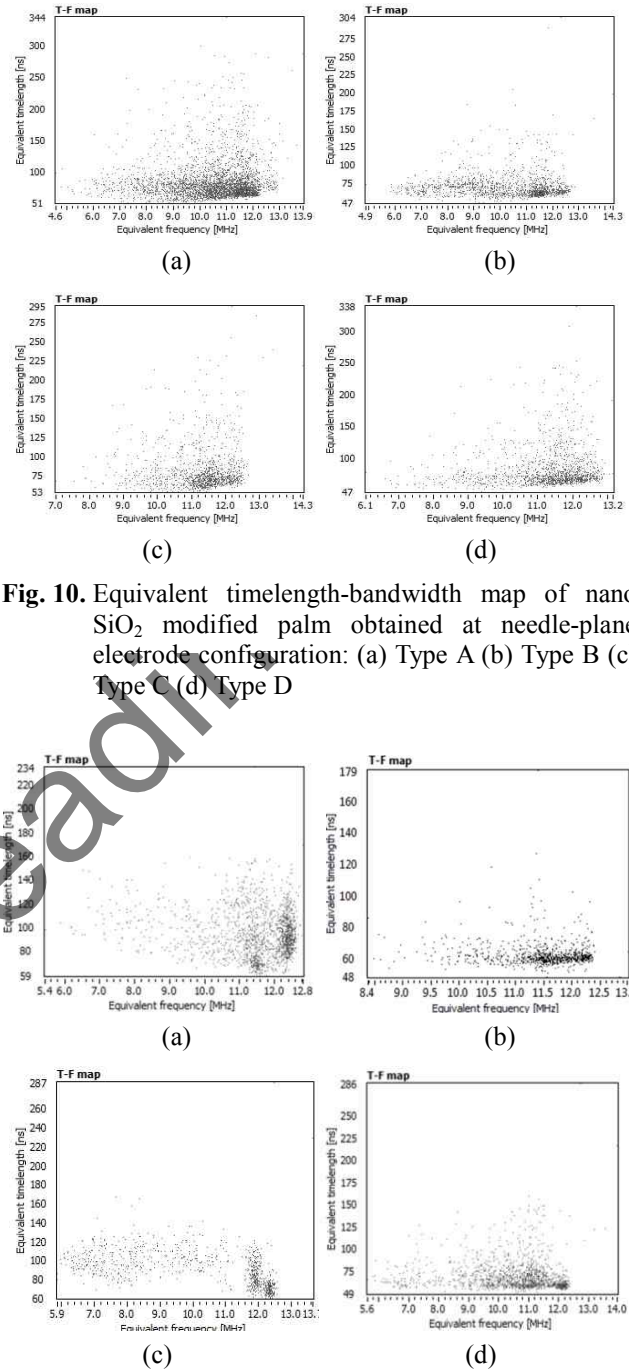


**Fig. 9.** Typical PD pulse and corresponding frequency spectrum of nano SiO<sub>2</sub> modified palm oil at different %wt concentration of nanofiller obtained at rod-plane electrode configuration: (a) Type A (b) Type B (c) Type C (d) Type D

value lies in the lower frequency band of 5 MHz. By visual inspection of both needle-plane and rod-plane PD signal waveforms, it is understood that corona discharge pulse occurs with slightly higher frequency characteristics compared with surface discharge PD. There is no major change in the frequency domain characteristics of nano modified palm oils compared with type A specimen.

**3.4 Equivalent Timelength-Bandwidth analysis of PD signals of nano modified palm oil**

Equivalent timelength-bandwidth analysis was carried out based on the concept explained already in [20-21]. This analysis is helpful in understanding the dependency of the



**Fig. 10.** Equivalent timelength-bandwidth map of nano SiO<sub>2</sub> modified palm oil obtained at needle-plane electrode configuration: (a) Type A (b) Type B (c) Type C (d) Type D

**Fig. 11.** Equivalent timelength-bandwidth map of nano SiO<sub>2</sub> modified palm oil obtained at rod-plane electrode configuration: (a) Type A (b) Type B (c) Type C (d) Type D

shape of PD signals with respect to the nature of PD sources. In short form, if  $s(t)$  is the time domain representation of PD signal, then equivalent time length and equivalent bandwidth are evaluated using,

$$\sigma_T = \sqrt{\int_0^T (t-t_0)^2 \tilde{s}(t)^2 dt} \tag{1}$$

$$\sigma_F = \sqrt{\int_0^{\infty} f^2 |\tilde{S}(f)|^2 df} \quad (2)$$

where  $f$  is the frequency,  $\tilde{S}(f)$  is the Fourier transform of the normalized pulse  $\tilde{s}(t)$ . Two real numbers obtained from Eqs. (1) and (2) are shown as a dot in the T-F mapping.

Fig. 10 and 11 shows the equivalent timelength-bandwidth map of nano SiO<sub>2</sub> modified palm oil at different %wt concentration of nanofiller obtained at needle-plane and rod-plane electrode configuration respectively. It is noticed that under needle-plane geometry, equivalent timelength of type A specimen lies in the range of 50-300 ns. Whereas nano modified oils show slightly reduced timelength of 50-250ns. In particular, type B specimen shows less than 200ns. Equivalent bandwidth of all samples under needle-plane geometry lies the range of 6-13 MHz. Addition of nanofillers at lower %wt concentration slightly reduced the timelength of PD signals. In the case of rod-plane geometry, it is noticed that type A specimen shows equivalent timelength in the range of 60-160ns. Type B specimen shows equivalent timelength in the range of 50-120ns, which is the lowest among other tested oil specimens. Under both electrode geometry, the equivalent timelength results of type D specimen (0.1%wt) are somewhat closer to the type A specimen. This shows that increasing the %wt concentration of nanofiller above 0.05%wt has less influence on the PD signal characteristics. Even though the equivalent bandwidth of both electrode geometry are similar in nature, there is a considerable difference in equivalent timelength of PD signals of nano modified palm oils. This feature can be used to identify the type of PD source exists in the insulation.

### 3.5 Analysis of weibull distribution parameters of PRPD pattern of nano modified palm oil

Accurate PD source identification of transformers depends on the statistical analysis of large amount of PD data. Reports on the PD statistical characteristics of the nano modified palm oils are scanty. Hence, in the present work, Weibull distribution analysis of the statistical features of PRPD patterns at both needle-plane and rod-plane geometry was carried out. Important statistical quantities such as scale parameter  $\alpha$  and shape parameter  $\beta$  of the Weibull distribution function of PRPD pattern are evaluated at different test conditions. Fig. 12 and 13 shows the variations in minimum, maximum and mean values of scale parameter and shape parameter of Weibull analysis at needle-plane and rod-plane electrode geometry respectively.

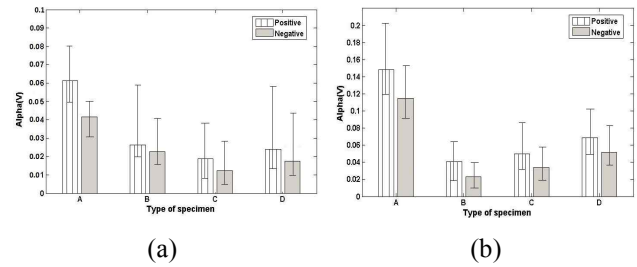


Fig. 12. Variations in Weibull parameter  $\alpha$  of PRPD pattern of nano SiO<sub>2</sub> modified palm oil at different %wt concentration of nanofiller obtained at (a) needle-plane electrode configuration (b) rod-plane electrode configuration

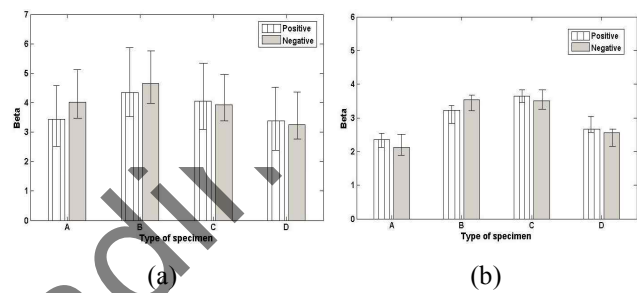


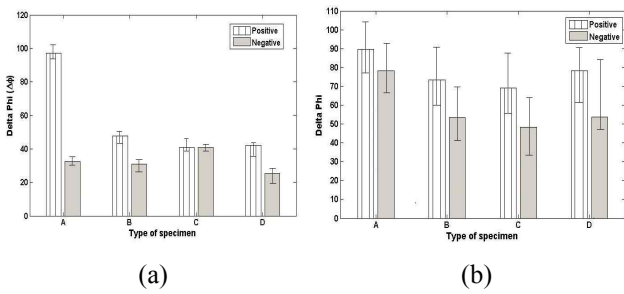
Fig. 13. Variations in Weibull parameter  $\beta$  of PRPD pattern of nano SiO<sub>2</sub> modified palm oil at different %wt concentration of nanofiller obtained at (a) needle-plane electrode configuration (b) rod-plane electrode configuration

with the PD amplitude, is noticed with type B and C specimen irrespective of the type of electrode geometry. Whereas considerable increase in  $\alpha$  is observed with type D specimen, which is also closer to type A specimen. This clearly shows that addition of lower %wt concentration of SiO<sub>2</sub> nanofillers considerably reduced the scale parameter.

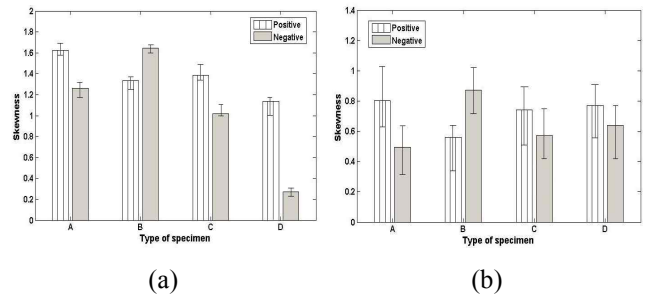
In the case of shape parameter  $\beta$ , which is an indirect measure of data dispersion of PRPD pattern, it is observed that type B and C specimen show higher value than type A and D specimen. This confirms that data dispersion is less with the addition of lower %wt concentration of nanofillers.  $\beta$  value lies in the range of 2-4 at rod-plane geometry and 3-5 at needle-plane geometry, making the PD source identification easier.

### 3.6 Analysis of phase angle parameters of PRPD pattern of nano modified palm oil

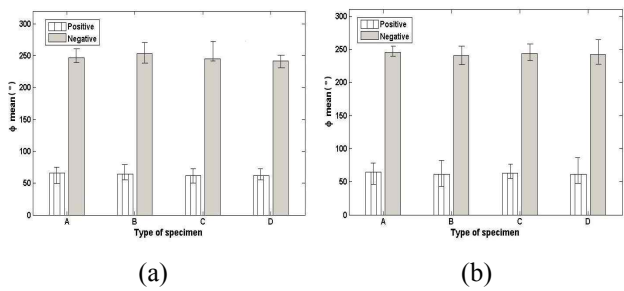
Fig. 14 and 15 shows the variations in  $\Delta\Phi$  and  $\Phi_{mean}$  of PRPD pattern of nano SiO<sub>2</sub> modified palm oil at different %wt concentration of nanofiller obtained at needle-plane electrode configuration and rod-plane electrode configuration respectively. It is clearly noticed that at needle-plane geometry, positive  $\Delta\Phi$  value of type A specimen is higher when compared with nano modified



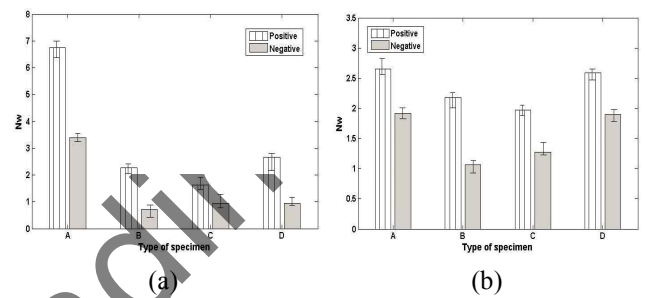
**Fig. 14.** Variations in  $\Delta\Phi$  of PRPD pattern of nano  $\text{SiO}_2$  modified palm oil at different %wt concentration of nanofiller obtained at (a) needle-plane electrode configuration (b) rod-plane electrode configuration



**Fig. 16.** Variations in skewness of PRPD pattern of nano Silica modified palm obtained at (a) needle-plane electrode configuration (b) rod-plane electrode configuration



**Fig. 15.** Variations in  $\Phi_{\text{mean}}$  of PRPD pattern of nano  $\text{SiO}_2$  modified palm oil at different %wt concentration of nanofiller obtained at (a) needle-plane electrode configuration (b) rod-plane electrode configuration



**Fig. 17.** Variations in  $N_w$  of PRPD pattern of nano Silica modified palm oil obtained at (a) needle-plane electrode configuration (b) rod-plane electrode configuration

palm oil specimens. At rod-plane geometry, significant reduction in positive  $\Delta\Phi$  value of type B and C specimen is noticed. This clearly indicates the presence of PD activities in the pure oil specimen and type D specimen in the majority of the portion of cycle of reference sine pattern. Whereas in the case of type B and C specimen, significant reduction in positive  $\Delta\Phi$  value indicates absence of PD activities in the majority of portion of reference sine pattern. However, with respect to  $\Phi_{\text{mean}}$  value of PRPD pattern, there is no considerable change in the values with respect to type of specimen at both electrode geometry. Since the majority of the PD signals lies in the short section of reference sine pattern, addition of nanofillers has less influence on the  $\Phi_{\text{mean}}$  value of PRPD pattern.

**3.7 Analysis of skewness and repetition rate of PRPD pattern of nano modified palm oil**

Fig. 16 and 17 shows the variations in skewness and repetition rate ( $N_w$ ) of PRPD pattern of nano  $\text{SiO}_2$  modified palm oil at different %wt concentration of nanofiller obtained at needle-plane electrode configuration and rod-plane electrode configuration respectively. Skewness is a mostly used to understand the distribution of data in the given PRPD pattern range. In general, it is noticed that

positive skewness value of type A specimen is considerably higher when compared with type B, C and D specimen, which indicates the reduction in symmetry of the PRPD pattern data of type A specimen. This shows that addition of nanofillers slightly improved the symmetry of the data. Another important parameter to be considered in PD analysis is the repetition rate of PD pulses, which is a direct measure of fast or slow degradation of insulation. However, in the case of liquid dielectrics, since the PD appear in pulse bursts, their repetition rate is highly irregular. From the results, it is clearly observed that repetition rate of type A specimen is higher when compared with nano modified palm oil specimens at both electrode geometry irrespective of the test specimen. Reduction in repetition rate is significant in the case of needle-plane geometry than rod-plane geometry. This confirms that addition of nano  $\text{SiO}_2$  fillers considerable improves the PD resistance and hence the repetition rate of PD pulses is reduced.

From the above reported PRPD pattern, PD signal time and frequency domain characteristics and statistical analysis of PD characteristics, it is generally noticed that addition of lower %wt concentration of nano  $\text{SiO}_2$  fillers, such as 0.01%wt and 0.05%wt, significantly improves the PD resistance of palm oil, when compared with pure oil and the results are in similar line with [6]. Further studies

on the long term thermal performance of nano modified palm oils are in progress, which will be useful to electrical utilities to find an alternate for conventional mineral oil.

#### 4. Conclusion

Laboratory PD experiments on nano modified palm oils at different %wt concentrations and at different electrode geometry were carried out as per IEC 60507 test procedure. Significant improvement in partial discharge inception voltage is noticed with 0.01 and 0.05%wt concentration of nano SiO<sub>2</sub> filler. When compared with pure palm oil, addition of SiO<sub>2</sub> nanofillers considerably reduced the PD repetition rate, PD equivalent time length and PD magnitude. Weibull parameter  $\beta$  shows considerable increase with addition of nano fillers, which confirms reduction in the dispersion of PRPD data pattern. PD activity in the positive half cycle is more severe when compared with negative half cycle and the results are in similar line with earlier reported works. It is shown that variations in the statistical parameters of PRPD pattern and PD pulses are closely related to the type of PD source and hence PD measurement will be a better diagnostic tool for condition monitoring of nanofluid insulation. These lab results on nano modified palm oil show that, addition of lower %wt concentration of nano SiO<sub>2</sub> fillers will certainly improve the PD resistance. However influence of nano fillers on the long term thermal performance of liquid insulation is to be investigated in future studies.

#### Acknowledgement

Author (S.Chandrasekar) would like to sincerely thank the CPRI, Bangalore for providing financial support through RSOP scheme for carrying out the research activities on nanofluid insulation for power transformer applications.

#### References

- [1] Chandrasekar, S and Gian Carlo Montanari, "Analysis of Partial Discharge Characteristics of Natural Esters as Dielectric Fluid for Electric Power Apparatus Applications," *IEEE Transactions on Dielectrics and Electrical Insulation*, vol. 21, no. 3 pp. 1251-1259, 2014.
- [2] Martin, N. Lelekakis, W. Guo, and Y. Odarenko, "Further Studies of a Vegetable-Oil-Filled Power Transformer," *IEEE Electr. Insul. Mag.*, vol. 27, no. 5, pp. 6-13, 2011.
- [3] Banumathi, S. and Chandrasekar, "Analysis Of Breakdown Strength And Physical Characteristics of Vegetable Oils for High Voltage Insulation Applications," *Journal of Advances in Chemistry*, vol. 12, no. 16, pp. 4902-4912, 2016
- [4] Kiasatina Azmi, Azmier Ahmad and Mohamad Kamarol, "Study of Dielectric Properties of a Potential RBD Palm Oil and RBD Soybean Oil Mixture as Insulating Liquid in Transformer," *Journal of Electrical Engineering and Technology*, vol.10, no.5 pp. 2105-2119, 2015.
- [5] Yee Von Thien, Norhafiz Azis, Jasronita Jasni, Mohd Zainal Abidin Ab Kadir, Robiah Yunus, Mohd Taufiq Ishak and Zaini Yaakub, "Evaluation on the Lightning Breakdown Voltages of Palm Oil and Coconut Oil under Non-Uniform Field at Small Gap Distances," *Journal of Electrical Engineering and Technology*, vol.11, no.1, pp. 184-191, 2016.
- [6] S.Senthilkumar, B.Karthik and S. Chandrasekar, "Investigations on PD Characteristics of Thermal aged Palm and Corn Oil for Power Transformer Insulation Applications," *Journal of Electrical Engineering and Technology*, vol. 9, no. 5 pp. 1660-1669, Sep 2014.
- [7] Banumathi, S. and Chandrasekar, S., "Aging effect on Partial Discharge Characteristics of Olive oil as an Alternative Liquid Insulating Medium. Research Journal of Applied Sciences, Engineering and Technology, vol. 9, no. 9, 745-754, 2015.
- [8] Huifei Jin, Thomas Andritsch, Ioannis A. Tsekmes, Roman Kochetov, Peter H.F. Morshuis, Johan J. Smit, "Properties of Mineral Oil based Silica Nanofluids," *IEEE Transactions on Dielectrics and Electrical Insulation*, vol. 21, no. 3, pp. 1100-1108, 2014.
- [9] Dong, M, L. P. Shen, H. Wang, H. B. Wang, and J.Miao, "Investigation on the Electrical Conductivity of Transformer Oil-Based AlN Nanofluid," *Journal of Nanomaterials, Hindawi Publishing Corporation*, vol. 2013, Article ID 842963, pp. 1-7, 2013.
- [10] Ramu, T.S., B.K. Keshavan, K.N. Balasubramanya Murthi, "Application of a Class of Nano fluids to improve the Loadability of Power Transformers," IEEE 10th International Conference on the Properties and Applications of Dielectric Materials, July 24-28, 2012, Bangalore, India, 2012.
- [11] Anandhan Elansezhayan, S. Chandrasekar, "Understanding The Lightning Discharge Withstand And Breakdown Characteristics Of Nano SiO<sub>2</sub> Modified Mineral Oil For Transformer Applications," *Journal of Advances in Chemistry*, vol. 12, no. 19, pp. 5200-5208, 2016.
- [12] Rongsheng Liu, Leif A.A. Pettersson, Tommaso Auletta, Olof Hjortstam, "Fundamental Research on the Application of Nano Dielectrics to Transformers," *IEEE International Conference*, pp. 423-427, 2011.
- [13] Y. Du, Y. Lv, C. Li, M. Chen, J. Zhou, "Effect of electron shallow trap on breakdown performance of transformer oil-based nano fluids," *J. Appl. Phys.*,



vol.110, pp. 104104-104104-4, 2011.

- [14] R. Liu, L. A. A. Pettersson, T. Auletta and O. Hjortstam, "Fundamental research on the application of nano dielectrics to transformer," *IEEE conf. Electr. Insul. Dielectric. Phenomena*, pp. 423-427, 2011.
- [15] Jian Li, Zhaotao Zhang, Ping Zou and Stanislaw Grzybowski, "Preparation of a Vegetable Oil-Based Nanofluid and Investigation of Its Breakdown and Dielectric Properties," *IEEE Electrical Insulation Magazine*, vol. 28, no. 5, pp. 43-50, 2012.
- [16] D. Prasad, S. Chandrasekar, "Investigations on Dielectric Performance Characteristics of Natural Ester based Nano-Fluids for Power Transformer Applications," *Asian Journal of Research in Social Sciences and Humanities*, vol. 6, no. 11, pp. 1146-1157, 2016.
- [17] D. Imamovic, K.X. Lai, N.A. Muhamad, B.T. Phung and T.R.Blackburn, "Partial Discharge and Dissolved Gas Analysis in Bio-Degradable Transformer Oil," in *Proc. of Cigre 16*, pp. 1-7, Brugge, 2007.
- [18] M. Pompili, C. Mazzetti and R. Bartnikas, "Partial Discharge Pulse Sequence Patterns and Cavity Development Times in Transformer Oils under ac Conditions," *IEEE Trans. Dielectr. Electr. Insul.*, vol. 12, no. 2, pp. 395-403, 2005.
- [19] Zhongdong Wang, Xin Wang, Xiao Yi and Sitao Li, "Gas Generation in Natural Ester and Mineral Oil Under Partial Discharge and Sparking Faults," *IEEE Electrical Insulation Magazine*, vol. 29, no. 5, pp. 62-70, 2013.
- [20] Andrea Cavallini, A.Contin, Gian Carlo Montanari, and F. Puletti, "Advanced PD inference in on-field measurements. Part I. Noise rejection," *IEEE Trans. Dielectr. Electr. Insul.*, vol. 10, pp. 216-224, 2003.
- [21] A.Cavallini, M.Conti, A.Contin and G.C.Montanari, "Advanced PD Inference in On-Field Measurements. Part.2: Identification of Defects in Solid insulation Systems," *IEEE Trans. Dielectr. Electr. Insul.*, vol.10, pp. 528-538, 2003.



**R.K.Arvind Shriram** was born in India in 1987. He obtained his B.E degree in Electronics and Communication Engineering in 2008 from Anna University. In 2012 he obtained his M.E degree in Power Electronics and Drives from Anna University. He is presently doing his Ph.D in Anna

University Chennai. His areas of research interest include control systems, signals and systems, high voltage engineering and power electronic FACT devices.



**S. Chandrasekar** was born in India, in 1975. He received the B.E. degree in Electrical and Electronics Engineering from Thiagarajar college of Engineering, Madurai in 1996 and M.E degree in Power Systems Engineering from Coimbatore Institute of Technology, Coimbatore in India in 2001

and the Ph.D degree from Indian Institute of Technology Madras, India in 2005. He was a postdoctoral research fellow at the University of Bologna, Italy from 2005 to 2006. Currently, he is working as a Dean (R&D) and Professor at Sona College of Technology. He is the head of SonaPERT (Electric Power Engineering Research and Testing Centre). His research interests include condition monitoring of power apparatus and systems, high voltage insulation engineering, signal processing and artificial intelligence techniques applications in electric power engineering. He has authored/co-authored more than 150 research papers.



**B.Karthik** was born in India, in 1982. He obtained his B.E degree in Electrical and Electronics Engineering from Annamalai University, Tamil nadu, India in 2003 and ME Degree in power systems engineering from Sona college of technology, Anna University, India in 2006 and Ph.D degree from

Anna University, Chennai in India in 2013. Presently, he is working as an Associate Professor at Sona College of Technology in the Department of Electrical and Electronics Engineering. His research interests are high voltage insulation systems, power flow control in transmission line, FACTS device for power quality and new technologies to enhance power system control and monitoring.